

University Entrance and Calculation of the TEA and ATAR

Paul Housley

Churchlands Senior High School

19 February, 2019



You must obtain the WACE first...

- Pathway direction (4 ATAR or Cert II +)
- Literacy & Numeracy (NAPLAN or OLNA)
- Breadth and depth (20+ units, List A&B)
- Achievement standard (14 x C+)
- WACE Examinations (Compulsory) – **recent penalty**
 - If not sit then whole subject won't count for anything!



YOUR MARKS

An outline of the processes used to make Year 12 results comparable so that the competition for university places is fair

University admission in WA

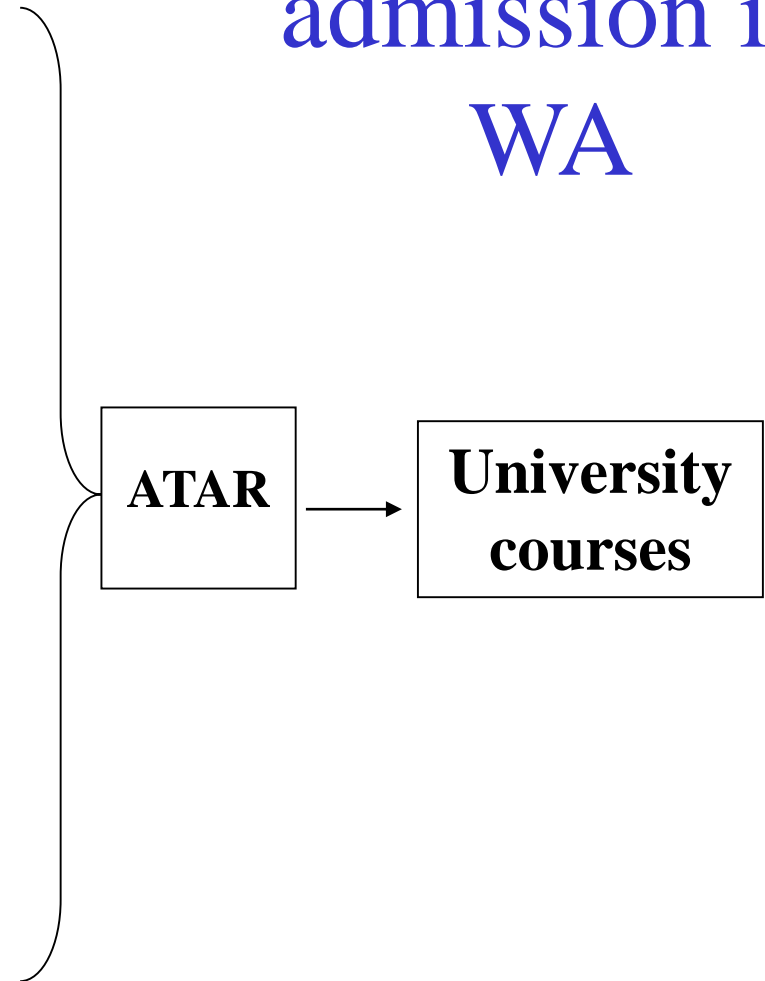
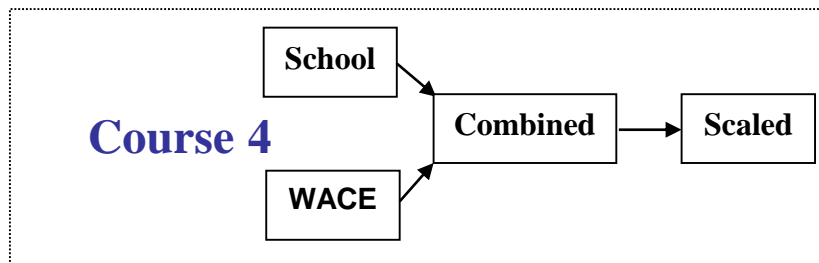
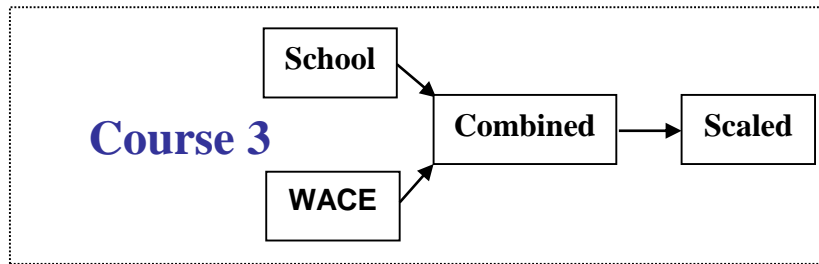
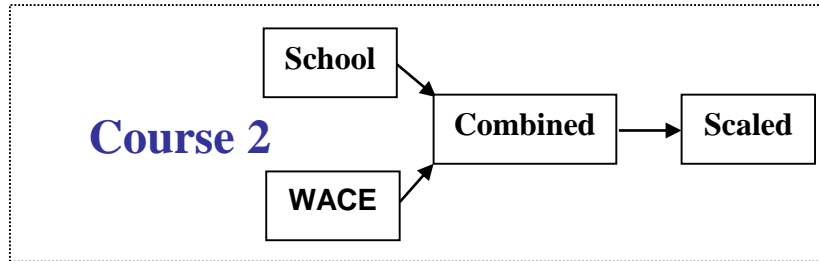
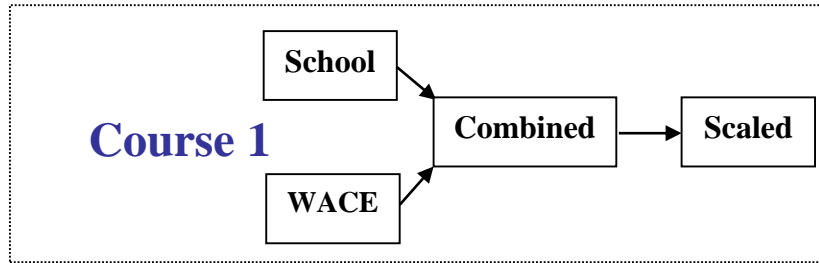

Marks adjustment process

- ❑ Because there are *differences in school marking*, school marks are adjusted to be on the same scale as the exam marks (*moderation*) – this evens out differences in school marking standards.
- ❑ Because there are *differences in exam difficulty* from year to year, combined marks are modified to a predefined distribution (*standardisation*) – marks distribution is fitted so that each subject has the same mean and standard deviation, Typically this has meant that the top mark is 100%, bottom is 0%, mean is 60% and standard deviation is 15%.
- ❑ Because there are *differences between subjects*, course combined marks are scaled (*average marks scaling*) - recognises that different courses have different levels of difficulty and this adjusts final marks accordingly.

Courses with Written Exams Only

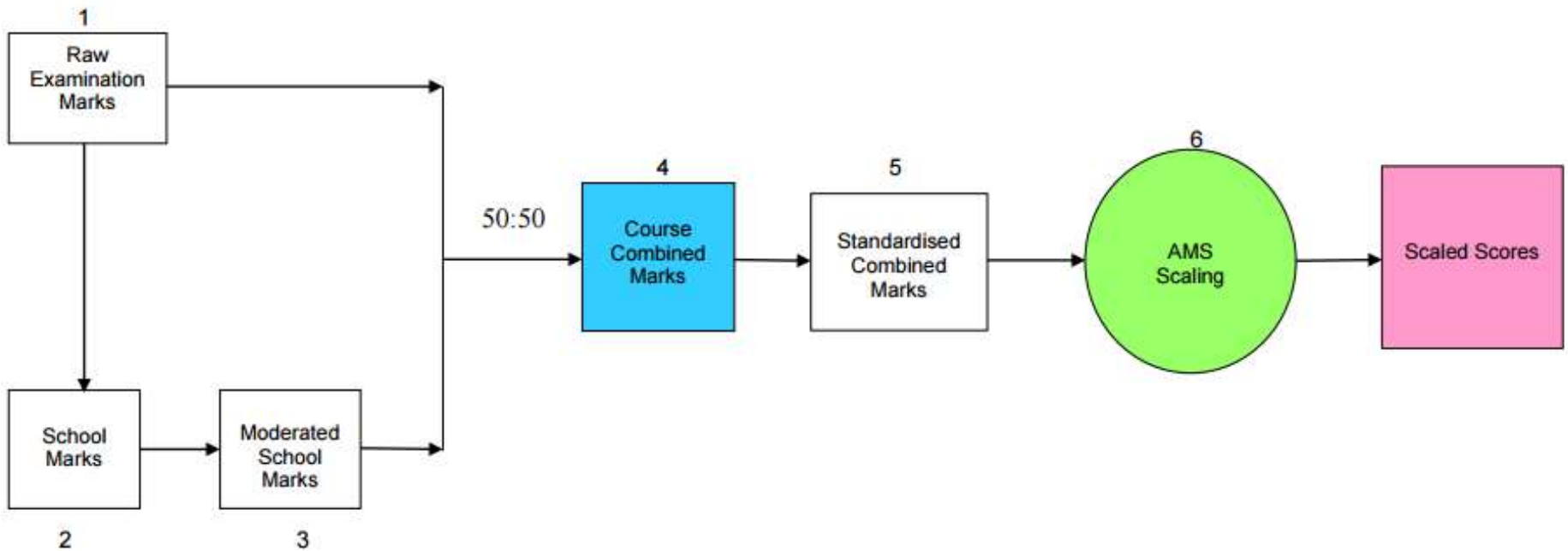

Courses with Separate Written and Practical Exams

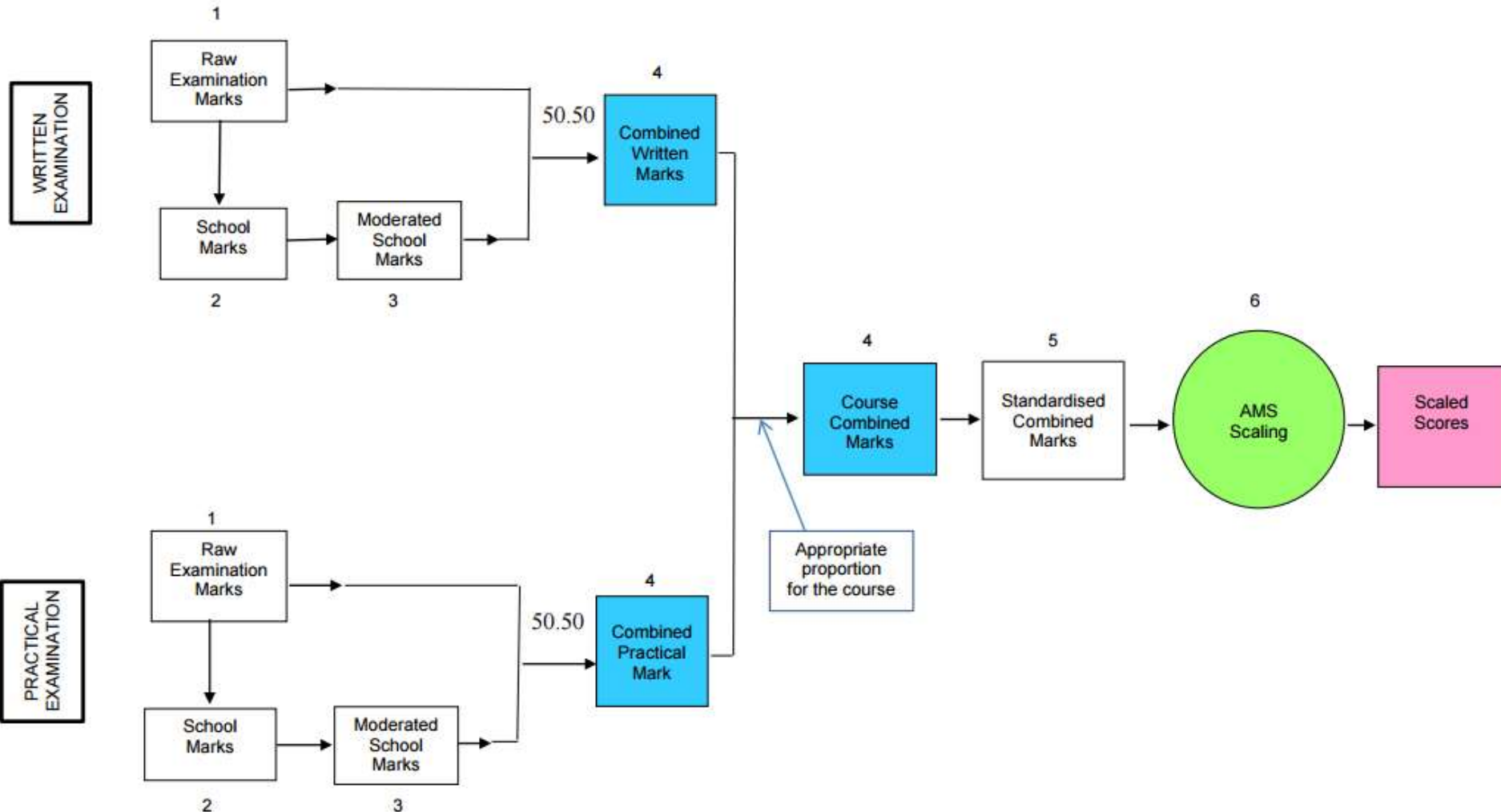

Why Scale?

- If marks were not scaled, students could be disadvantaged if they chose challenging courses.
- In principle, if other factors are ignored, a student of a given ability is expected to get the same Scaled Score whatever course he/she decides to take.
- A scaled score of 65 in Physics is the same as a 65 in English or a 65 in Dance.

What do students study?

Either

- Certificate courses – count for graduation (WACE) and may help for TAFE entry
 - Certificate II = 2xYear 11 units + 2xYear 12 units
- WACE Courses – made up of 2 units studied over year
 - either ATAR or General
 - need at least 4 ATAR courses for Uni
 - get a grade and a mark out of 100 (which will be the same for both units)

Applying for University

- The standard pathway is to apply through TISC for entry to UWA, Curtin, ECU and Murdoch.
- This pathway involves the calculation of an ATAR.
- There are alternative entry process for some Universities like the Portfolio Pathway at ECU.
- Notre Dame is a private University in Fremantle. Students must apply directly for entrance.

TISC Admission Requirements

1. Obtain the **WACE** (ie Secondary Graduation)
Anyone who did Year 11 overseas/interstate needs to get credit from SCSA – see me ASAP!
2. Competence in **English** (Scaled score of **50%** or more in English, EALD or Literature)
3. Get a high enough **ATAR** for the course wanted
4. Meet any course **prerequisites**
Scaled mark of at least 50% in certain ATAR courses.

Courses which count for University

Accounting & Finance

Biology

Chemistry

Chinese SL

Computer Science

Dance

Drama

Earth & Environmental Science

Economics

English

EALD

French SL

Geography

Health Studies

History Ancient

History Modern

Human Biology

Japanese SL

Literature

Maths Applications

Maths Methods

Maths Specialist

Media Production & Analysis

Music (Jazz)

Music (Western Art)

Philosophy and Ethics

Phys Ed Studies

Physics

Politics & Law

Psychology

Visual Arts

Unacceptable Course Combinations

The following course combinations are not acceptable in relation to the calculation of the ATAR. Both courses may be taken but the result in only one may be used to calculate an ATAR. (There are other unacceptable combinations but these are the main ones affecting Churchlands students)

- English and Literature
- English and EALD
- EALD and Literature
- Maths Applications and Maths Methods
- Maths Applications and Maths Specialist.

- All bonuses apply.

Exams

- School exams are part of the assessment program for all of the ATAR courses. Compulsory to sit!
- Students studying ATAR courses (even only 1 of them!!) must sit the external WACE exams as part of graduation. **If they do not sit and try for the WACE exam then they will get no recognition of the subject for any WACE requirement! 1 student failed to graduate last year because of this!**
- If students are studying 4 or more ATAR courses then the best 4 scaled scores will be used to calculate the ATAR for university entrance (along with 10% of Maths Methods, Maths Specialist or any Language course undertaken).

Be Careful of Scaling!

- The final mark you walk away from school with is affected by all the processes mentioned earlier: WACE exam performance, moderation, standardisation and scaling.
- The final mark can look quite different.
- Subjects can be scaled up or down but at Churchlands we are very often within + or – 5% of the marks we submit to SCSA.
- This is because at Churchlands we **standardize all our marks** based on historical performance. (Regular feedback)
- You can only try your very best at all that you do.

Firstly a TEA is calculated...

1. Identify your four best course scaled marks.
2. Add together these four marks.
3. Add 10% of any Language course done, Maths Methods and/or Maths Specialist.
4. This gives a possible total out of 430.
5. This total is called the Tertiary Entrance Aggregate (TEA).

Example 1 – Four ATAR Courses

Physics	67.6
Maths Applications	66.5
English	55.4
Human Biology	41.5

Four course total, no language or high-level Maths done: $67.6 + 66.5 + 55.4 + 41.5 = 231$

- Therefore TEA = 231
- NOTE: this produced an ATAR of 75.9 last year!

Example 2 – Five ATAR Courses

■ Maths Applications	83
■ Literature	54
■ French SL	80
■ Physics	77
■ Chemistry	75

Best four course total = $83 + 80 + 77 + 75 = 315$

Add 10% of the French mark +8 gives 323.

- Note the “English”, language or maths marks do not need to be in the top four.
- This produced an ATAR of 97.2 last year!

Example 3 – Various Bonuses!

■ Maths Methods	90
■ English	73
■ Maths Specialist	80
■ Japanese SL	60
■ Chemistry	81

Best four course total = $90+81+80+73 = 324$

- Now add 10% of Methods, Specialist and Japanese marks to total so TEA would become:

$$324 + 9 + 8 + 6 = 347$$

- Last year the ATAR would have been 98.85.
- NOTE: You can sit a language as a non-school Candidate!
Spoke to interested students last week – Forms on web...

Non-school Candidate

- Can enrol as a non-school candidate in a language, either from WA or “interstate”.
- Languages include: Spanish, Russian, Vietnamese, Hindi, Serbian, Dutch, Portuguese...
- Will only sit the “WACE” exam and get a mark. Won’t do marked work over the year or get a grade.
- Can view past exams on the internet for practice.
- Cost - \$57 if only a written exam, \$114 if also a practical exam.
- Applications due Thursday 4 April.

The TEA is used to form the ATAR

- The TEA for every student in the state is ranked from highest to lowest.
- The ATAR is assigned to show how each student ranks compared to all Year 12's in the state.
- An ATAR ranges between 99.95 and zero, and reports your rank position relative to all other students. It takes into account the number of students who sit the WACE exams in any year and also the number of people of Year 12 school leaving age in the total population.

- An ATAR of 95 means that you are ranked in the top 5% of the state. You are equal to or better than 95% of the state.
- It doesn't mean you have to average 95%!
- An ATAR of 85.1 (the median ATAR at Churchlands SHS last year) means you are ranked in the top 14.9% of the state and equal to or better than 85.1% of the state.
- It doesn't mean you have to average 85.1%!!

- TISC have published an approximate TEA to ATAR calculator on their website as a guide.
- www.tisc.edu.au

TISC

UNDERGRADUATE ▾ INTERNATIONAL ▾ STAT ▾ RESOURCES ▴

ABOUT ATAR
ATAR CALCULATOR
SCALING
STATISTICS
DOWNLOADS
FORMS
SCHOOL CIRCULARS
SUBSCRIBE
TISC GUIDE

Tertiary Institutions Service Centre, Western Aust

Five steps to university admission
Applying to uni is easier than you think . . .

[READ MORE](#)

KEY DATES

1
MARCH
2018

Last Day to View
Last day to access your application and for WA year 12s to view their results online.

NEWS

Information about your offer
What are your options if you've been made an offer?

How does course average affect ATAR??

- This can vary slightly from year to year. All these figures assume no “bonus” so ATAR could be higher if studying a language, methods or specialist.

Scaled Score Average	ATAR 2012	ATAR 2013	ATAR 2014	ATAR 2015	ATAR 2016	ATAR 2017	ATAR 2018
50	60.95	60.95	60.15	60.35	61.2	61.2	61.05
55	69.35	69	68.6	69.1	70.7	70.95	70.8
60	76.9	77	76.9	77.2	79.1	79	79.35
65	84.15	84.05	84.05	84.45	85.75	85.55	85.9
70	90	89.9	89.9	90.1	91.05	90.55	90.85
75	94.3	94.25	94.15	94.25	95.05	94.3	94.55
80	97.15	97.15	97.15	97	97.5	96.85	96.95

Effect of a 5% improvement

Course Average (Scaled Marks)	ATAR in 2017	Effect on ATAR		ATAR in 2018	Effect on ATAR
50	61.2	ATAR increases by 9.75		61.05	ATAR increases by 9.75
55	70.95			70.8	
75	94.3	ATAR increases by 2.55		94.55	ATAR increases by 2.4
80	96.85			96.95	

Selection Ranks

- For most courses, Year 12 students will be selected for admission to university on the basis of their ATAR.
- However, some universities assign WACE students who are eligible for alternative entry pathways a Selection Rank that's higher than their ATAR. For these students, selection into courses is based on this enhanced Selection Rank assigned by the university concerned.

Minimum ATARs for University Courses

- All Universities set an eligibility benchmark ATAR
- This is the minimum ATAR to enter a course at that University. It does not necessarily allow entry to competitive courses.

For 2019 entry, the eligibility ATAR's were:

- Curtin 70 (higher for some courses)
- ECU 70 (higher for some courses)
- Murdoch 70 (higher for some courses)
- UWA 80 (higher for some courses like 98 for B. Philosophy)

Lowest Offered Ranks (formerly “cut off ranks”)

- The final cut-off ATAR depends on factors such as the number of places offered in the course and how many students apply for the course.
- In general, the cut-off is the ATAR achieved by the lowest ranked person accepted into the course.
- Previous year cut-offs should be used as a guide only, they are often similar but sometimes can be quite different as may be affected by external factors e.g. fee increases, the state mining economy etc.

Guaranteed ATARs

- If you achieve the Guaranteed ATAR/Selection Rank for a course, you are guaranteed acceptance into that course, provided you also achieve WACE, English Competency and a scaled score of 50 or more in the ATAR course prerequisites listed for the university course.
- Not all courses have a guaranteed ATAR.
- **Further information available from TISC website under:
Undergraduate – Entry requirements – School Leavers
– ATARs and Ranks**

Alternative Entry

Each University makes some allowances.

For example Curtin have the **Uniready Enabling Program** and ECU have **Experience Based Entry Scheme**....

Curtin Uniready Enabling Program may help you qualify for some (but not all) courses in Health Sciences, Humanities, Business, Science and Engineering.

It is an excellent option if you:

- Narrowly missed getting ATAR of 70
- Completed Year 12 but didn't take WACE exams
- Have completed vocational studies

Alternative Entry

ECU Experience Based Entry Scheme

– **check website for updates!**

If you had a near-miss ATAR for chosen course

OR

If you don't have an ATAR and you:

- Completed WACE
- Met “English competency” C or better in ATAR English or A in General English.
- Satisfied any pre-requisites

Will require an intro letter, resume, academic records, two written references and possible interview.

Further Information.....

- Make yourself very familiar with the Tertiary Institutions Service Centre (TISC) website.
- www.tisc.edu.au
- (Remember this or just Google TISC!!!)
- Notre Dame University has different entry processes and have an early offer scheme. Check their website for further information.
- www.nd.edu.au/fremantle (or Google it !!!)

Interstate Universities

- Australia has nearly 39 universities, both public and private.
- WA students are welcome to apply to interstate universities too.
- The various university websites can be accessed via: www.universitiesaustralia.edu.au
- Each state has the equivalent of TISC which handle applications. NSW & ACT = UAC, SA and NT = SATAC, Qld = QTAC, Vic = VTAC

Some Points to consider...

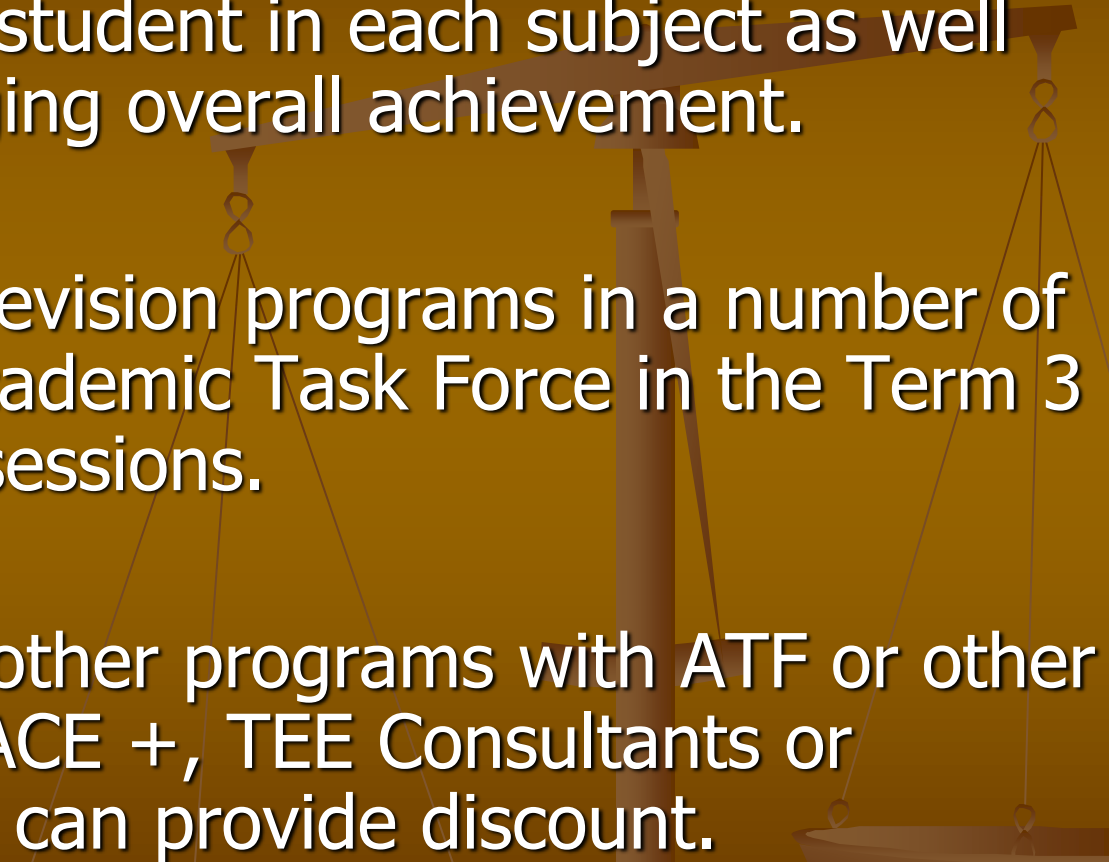
- At the Presentation Ceremony there will be awards and prizes for the top student in each subject as well as awards acknowledging overall achievement.
 - We offer subsidized revision programs in a number of WACE courses with Academic Task Force in the Term 3 vacation - 5 x 2 hour sessions.
 - Students can access other programs with ATF or other companies such as WACE +, TEE Consultants or Mastermind. We often can provide discount.
- 

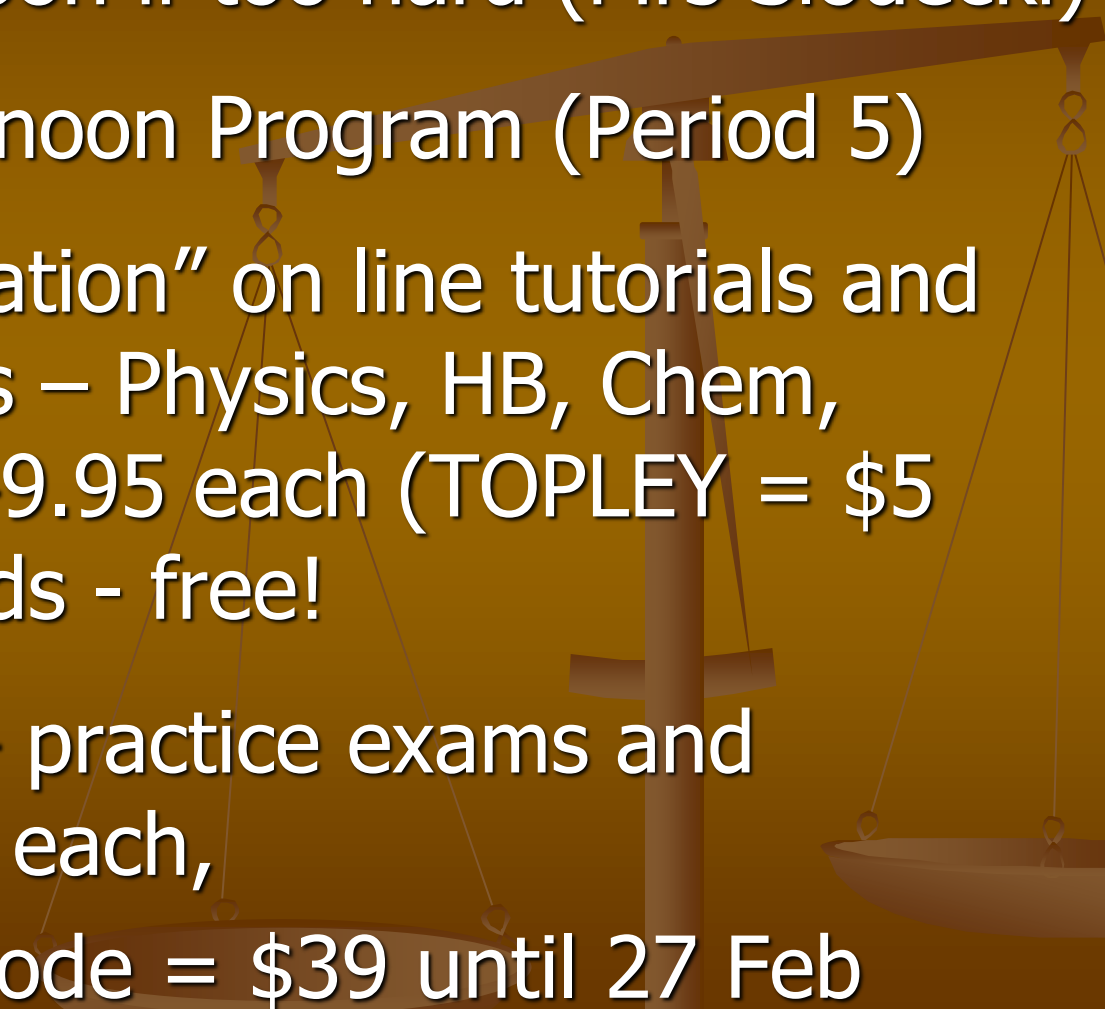
- 
- Rigorous Testing over first 6 weeks.
 - Change course soon if too hard (Mrs Slodecki)
 - Wednesday Afternoon Program (Period 5)
 - “Step Up in Education” on line tutorials and practice problems – Physics, HB, Chem, Specialist – all \$49.95 each (TOPLEY = \$5 discount), Methods - free!
 - “Revise Online” – practice exams and assessments \$44 each,
Churchlands code = \$39 until 27 Feb



REVISE
ONLINE



**EXCLUSIVE
CHURCHLANDS
DISCOUNT:
SAVE \$5 PER
COURSE***

ATAR PRACTICE TESTS AND EXAMS

FOR EXAM PREP THAT GETS RESULTS

Year 11 & 12

- Biology
- Chemistry
- Economics
- English
- English Lit
- Human Biology
- Math Apps
- Math Methods
- Math Specialist
- PE Studies
- Physics
- Psychology

**DISCOUNT
CODES:
CSHS11
CSHS12**

Exam Builder	Marking Keys	Sample Answers
Track Use	WACE Specific	Self Marking MC
Includes Past ATAR Q's	Sets Timer	Scientific Enquiry Q's



"I was pleased to see my son so engaged in his study. He was constantly praising the ability of the program to help him improve his exam technique."

Parent - Wesley College



"Through practicing questions in these exam conditions, I was able to improve my grades as I was preparing myself for these stressful assessment conditions."

Year 12 student - Trinity College

* Terms and conditions. For exclusive use of Churchlands students only. Codes valid until 27/2/19. \$5 off per course. Year 11's must use code CSHS11, Year 12's use code CSHS12. All sales final. Enquiries to enquiries@reviseonline.com

www.reviseonline.com/wace

Step Up In Education

Step Up In Education is a collection of amazing online resources for Western Australian high school students. Subjects are delivered via video tutorials which are designed and presented by real, down to earth, professional, Western Australian teachers with the experience to know what it is students must be able to do in WACE exams. The practice problems presented give students guidance in how to solve exam style questions. Check out the sample pages for any of the subjects below.

Science

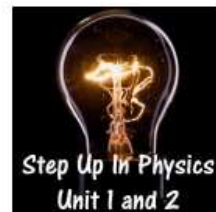



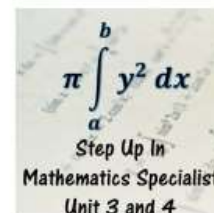
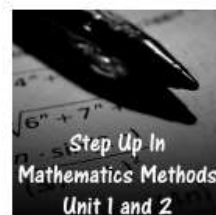

Mathematics



Australia's #1 study skills provider

Watch Film

I am a...

 Teacher	 Student
 Job applicant	 Parent

Improving student performance at over 1500 schools through high impact study skills workshops



Australia's largest study skills provider



Multi-award winning



World-class STEM curricula

Since 2001, Elevate has been transforming the way study skills programs are run across Australia. Drawing upon over 15 years of research into the

Elevate's reputation for achieving behavioural change has led the company to become an international leader in education, working with over

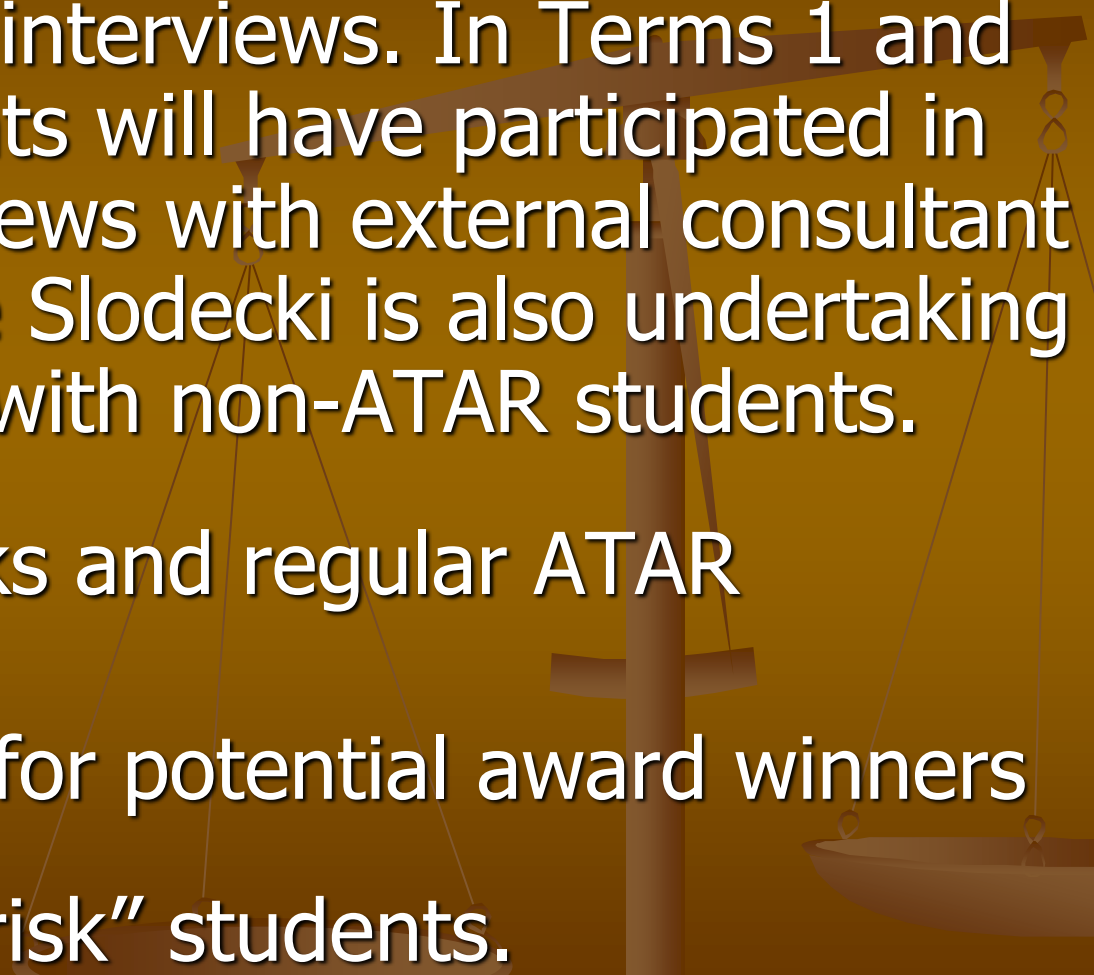
- 
- Breakfast Club for top students with predicted ATAR of 95 or above. (New students after S1)
 - Personal planning interviews. In Terms 1 and 3, all ATAR students will have participated in one on one interviews with external consultant Sally Topley. Clare Slodecki is also undertaking similar interviews with non-ATAR students.
 - Standardized marks and regular ATAR predictions.
 - Incentive lunches for potential award winners
 - Mentoring for “at risk” students.

School Curriculum and Standards Authority Awards

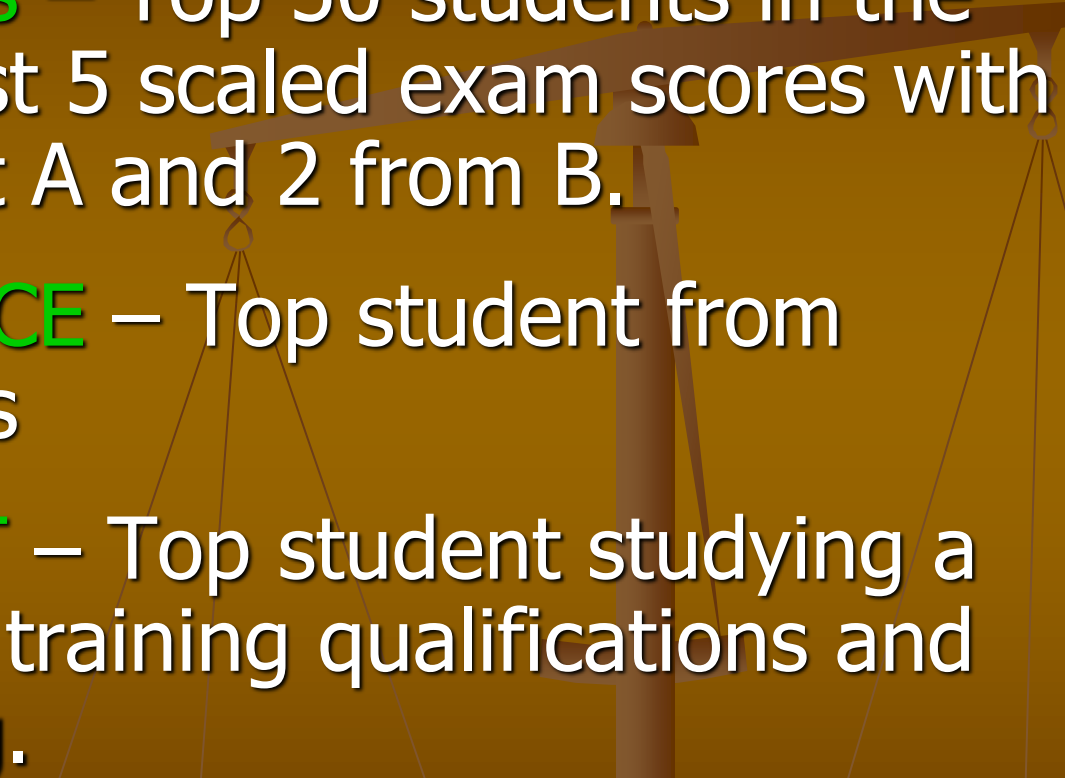
- **General Exhibitions** – Top 50 students in the state based on best 5 scaled exam scores with at least 2 from List A and 2 from B.
 - **Beazley Medal WACE** – Top student from General Exhibitions
 - **Beazley Medal VET** – Top student studying a program including training qualifications and workplace learning.
- 

School Curriculum and Standards Authority Awards

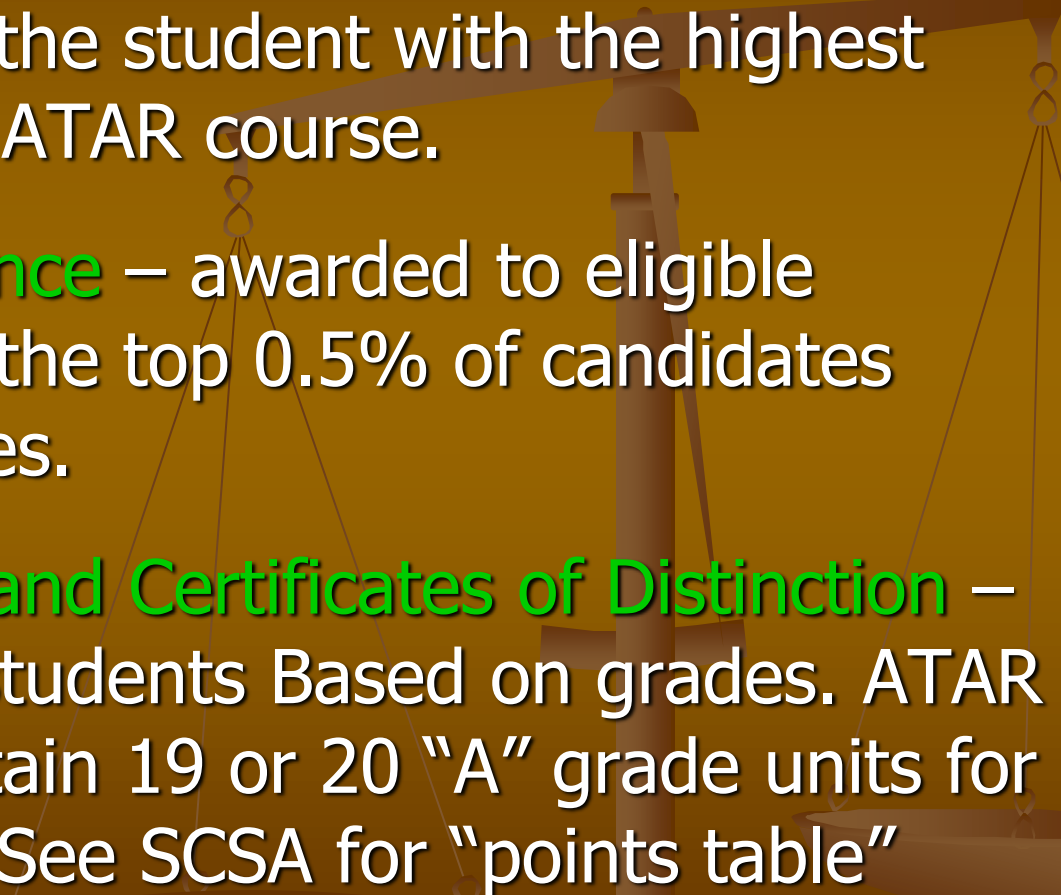
- **Subject Exhibition** – the student with the highest exam mark for each ATAR course.
 - **Certificate of Excellence** – awarded to eligible students who are in the top 0.5% of candidates based on exam scores.
 - **Certificates of Merit and Certificates of Distinction** – awarded to eligible students Based on grades. ATAR students need to obtain 19 or 20 “A” grade units for the Cert Distinction. See SCSA for “points table”
- 

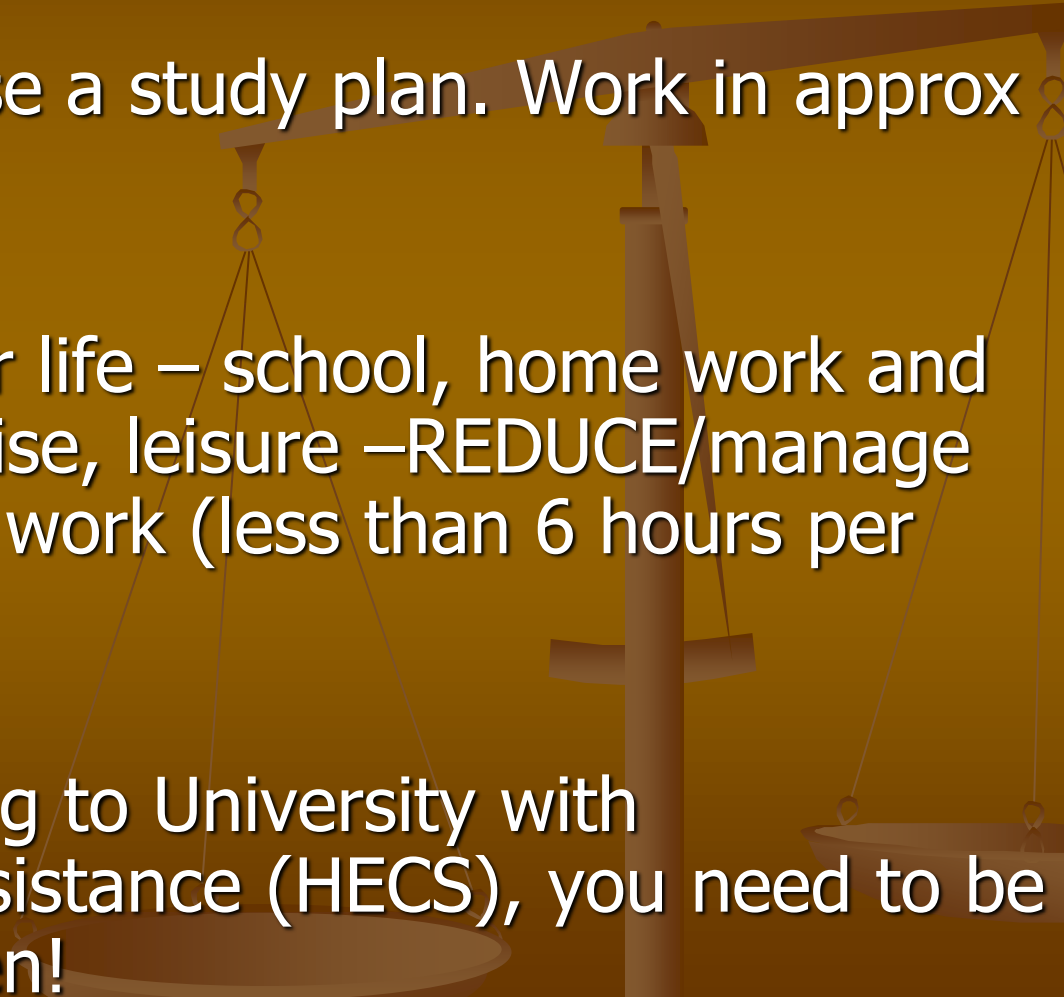
- 
- Homework Club runs on Mondays and Tuesdays after school in the Library. An excellent place to catch up and get free help!
 - Plan your time!! Use a study plan. Work in approx 1 hour blocks.
 - Get balance in your life – school, home work and study, sleep, exercise, leisure –REDUCE/manage social life and paid work (less than 6 hours per week).
 - If you plan on going to University with Commonwealth assistance (HECS), you need to be an Australian Citizen!

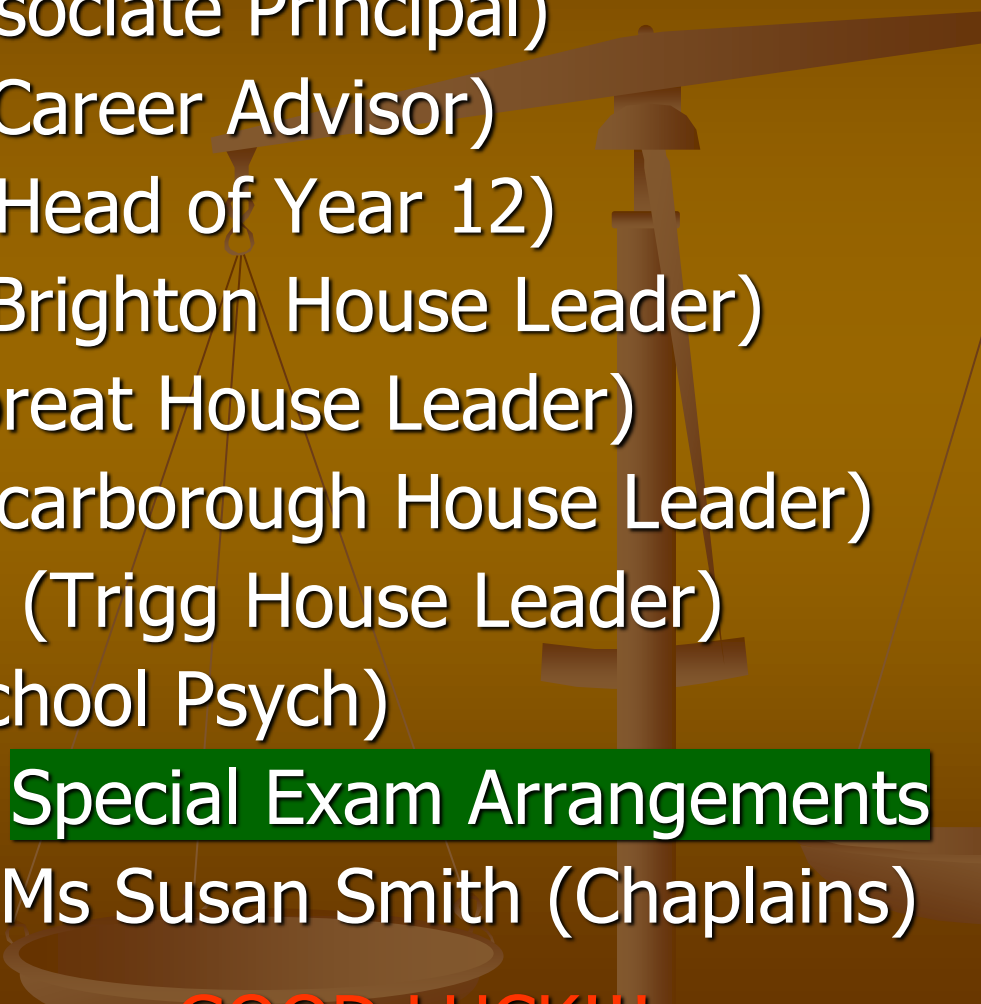
- 
- **Special Exam Arrangement** forms and **Sickness or Misadventure** forms – apply appropriately
 - People you can see for advice and support:
 - Mr Paul Housley (Associate Principal)
 - Mrs Clare Slodecki (Career Advisor)
 - Mr Andy Chapman (Head of Year 12)
 - Mrs Sandy Harvey (Brighton House Leader)
 - Mr Roger Harris (Floreat House Leader)
 - Ms Leah Anthony (Scarborough House Leader)
 - Mr Richard Massang (Trigg House Leader)
 - Ms Jan McArthur (School Psych)
 - **Mrs Jane Price** – for **Special Exam Arrangements**
 - Mr Andrew Winton/ Ms Susan Smith (Chaplains)
 - Try as hard as you can – **GOOD LUCK!!!**



Clare Slodecki
SCHOLARSHIPS
2019/2020



SCHOLARSHIPS TO UNIVERSITY

WHY APPLY FOR A SCHOLARSHIP?

- Prestige....looks great on a resume
- Financial Support.....\$\$\$\$\$
- Scholarships are an investment in the student
- Opportunities for overseas exchange etc.
- They might get one.....if they don't try, they won't know 😊

What can students apply for?

There are a wide range of scholarships available to prospective first-year university students. There are also many scholarships administered by other organisations to support students with their financial expenses.

Types of scholarships available:

- Academic Excellence / Merit – some are automatic
- Community Service / Leadership
- Social inclusion and equity and awarded on the basis of financial need and/or other hardship
- Accommodation Support



International Scholarships and Applications

- *Please make careful note of application due dates.*
- *Please endeavour to give the school plenty of time to attest copies of academic results...this can't always be done immediately.*
- *If the school is required to act as a 'referee' make sure that you have asked the person that you have nominated....these applications can be a problem if the University is in the Northern Hemisphere and the 'referee' is on Summer holidays.*



IMPORTANCE OF COMMUNITY SERVICE

Many of the scholarships require demonstration of leadership and community service.....even when Academic excellence is clearly evident.



COMPLETING AN APPLICATION

- No Scholarship application is alike....efficiency is the key to a good application.
- Make multiple copies of documents that might be needed scan and save as PDF's.
- Create a working draft.
- Answer every question
- Proof read.....check, check and check again.
- Always keep a copy



*The scholarship application is a paper/online model of the applicant.
It is essential that the application is professional and compelling.*

SCHOLARSHIP SUCCESS

Two John Curtin Undergraduate Scholarships in 2011

two in 2012 😊

none in 2013 😞

one in 2014 😊

no applicants in 2015 😞

one in 2016 😊

None in 2017 😞

One in 2018 😞...first male...yippee!!

...would be great to have another in 2019

....even better two !!



2018 SCHOLARSHIP SUCCESS

- John Curtin Undergraduate Scholarship, Curtin University Principal's nomination (2)
- Murdoch Excellence Scholarships
- Edith Cowan University Principal's Nomination, Engineering Excellence and General Excellence scholarships.
- UWA Principal's Nomination and excellence scholarships
- Many other scholarships based on ATARs

Scholarships offer financial and academic support....they look fantastic on a resume!!



WHAT SKILLS WILL BE REQUIRED IN THE 21ST CENTURY

